

⚠ WARNING DO NOT CONNECT DIRECTLY TO HIGH VOLTAGE POWER!
Read all warnings and installation instructions thoroughly.

SAFETY & WARNINGS

- Install in accordance with national and local electrical code regulations.
- This product is intended to be installed and serviced by a qualified, licensed electrician.
- This product must be powered with a compatible Class 2 DC Constant Voltage LED driver (power supply).
- DO NOT power tape light while attached to plastic spool or tightly coiled. Excess heat may melt the spool and/or cause damage to the fixture.
- DO NOT install in location where LED chips are exposed to direct sunlight or damage to the phosphor will occur.
- Ensure applicable wire is installed between driver, fixture, and any controls in between. When choosing wire, factor in voltage drop, amperage rating, and type (in-wall rated, wet location rated, etc.). Inadequate wire installation could overheat wires, and cause a fire.
- Tape light, attached wire leads, and additional extension cables, connectors, etc., are not rated for in-wall installation unless otherwise noted. Use wires rated for at least 176°F (80°C) and certified for use with external connection of electrical equipment.
- Connectors have a Class 2 amp limit unless otherwise noted.
- Each tape light has a different power consumption rating and maximum run length that must be individually wired to a compatible low voltage (PWM) control or DMX decoder. Refer to tape light package label or spec sheet for more information.
- Only wet location tape light models are rated for outdoor / wet locations. See package label for environment ratings.
- Tape light must be handled with care. Excessive handling, bending, and pressure may damage the product, voiding the warranty.



QUICK SPECS

Input Voltage	24VDC constant voltage
Power Consumption	Max: 2.92W per foot
Maximum Run	See package label

Included Model(s)	DI-24V-KRNG-**
Ambient Temperature †	-4° ~ 122°F (-20° ~ 50°C)
Environment	Dry / wet location (model dependant)

** Indicates spool length

† Do not install product in an environment outside the listed ambient temperature.

TAPE LIGHT HANDLING

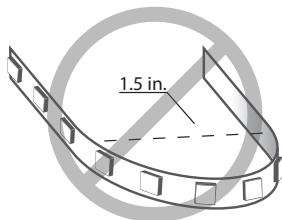

Do not bend LED strip light to a diameter less than 1.5 inches.

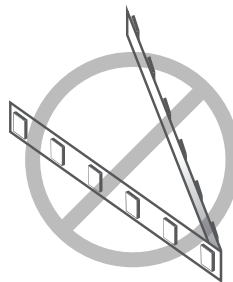

Do not fold or crease LED strip light.

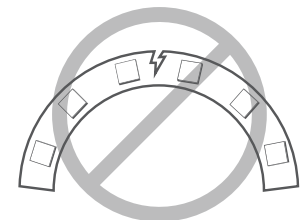

Do not bend LED strip light on a horizontal plane.

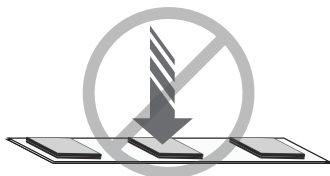

Do not put excessive pressure on surface of strip light (e.g. glass/acrylic panes etc.).

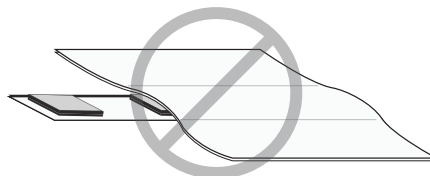

Do not cover strip light with any materials.

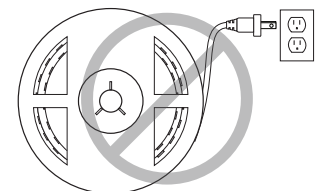

Do not power strip light while attached to spool or tightly coiled.

INSTALLATION

Prior to installation, verify all components are a compatible system. Configure and pre-test your LED system prior to permanent installation to ensure all components are operating correctly. Install in accordance with national and local electrical codes.

1 Turn OFF High Voltage AC Power at the main breaker.

WARNING Shock Hazard. May result in serious injury or death. Turn off power at circuit breaker before installing this product.

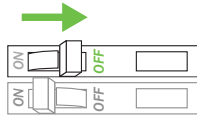

2 Determine Locations to Install 3 Main Components. Refer to the 'System Diagrams.'

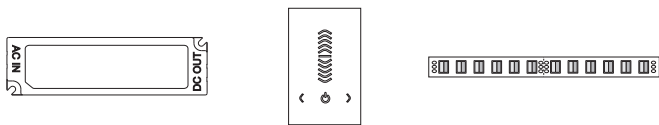

1) Driver 2) Adjustable Kelvin Controller 3) Fixture

WIRE GAUGE & VOLTAGE DROP

Ensure applicable wire is installed between driver, fixture, and any controls in between. When choosing wire, factor in voltage drop, amperage rating, and type (in-wall rated, wet location rated, etc.).

3 Prior to cutting tape light, refer to 'K-RANGE® CLICKTIGHT™ Connectors' on page 3 for connection information.

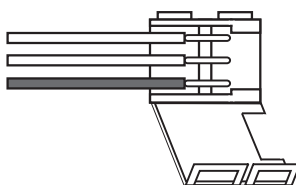

4 Mount tape to desired surface.

A. Cut the tape at the line indicated with the scissors icon.

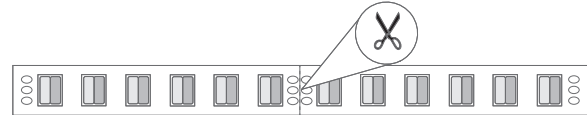

Cut points not drawn to scale.

B. Determine a finished, smooth surface, away from direct sunlight for mounting. Clean surface and let dry.

C. Remove adhesive paper from the tape light to expose 3M™ adhesive. **Ensure ambient temp is minimum 50°F (10°C) or tape will not adhere properly.**

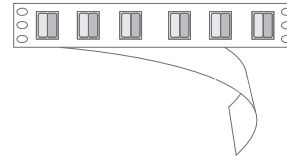

D. Adhere tape to surface, working one end to the other to prevent air pockets and raised sections. Utilize a clean rag between skin and tape to resist oil transfer from skin to LEDs. Continue following the remaining installation instructions.

5 Attach adjustable kelvin controller and driver. **Only use copper wiring.** Reference 'Wiring Connections' located further in guide for visual. Verify a compatible constant voltage driver is installed.

6 Review the full system. Ensure all polarities are correct and connections are secured.

7 Install Additional Components, Verify Connections, and Turn Main Power ON at Breaker.

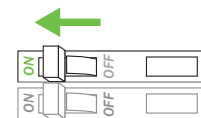

SYSTEM WORKING IMPROPERLY?

Turn OFF main power at breaker and verify all connections. Review the 'Wiring Connections', 'System Diagrams', and dimming control installation guides.

K-RANGE[®] CLICKTIGHT™ CONNECTORS

These instructions apply only to K-RANGE[®] CLICKTIGHT™ Connectors (does not apply to solid color CLICKTIGHT™ Connectors). Never cut tape attached to a live circuit.

1 Cut the tape at the line indicated with the scissors icon.

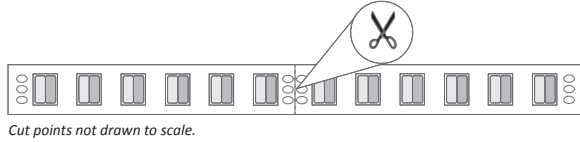

2 Open the CLICKTIGHT™ latch and note the +/- polarity markings.

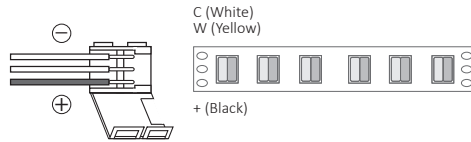

3 Firmly insert the tape light into the connector tray with the 3M™ adhesive backing still intact to the tape. Ensure the contact/solder points of the tape are directly underneath the metal placement tabs of the connector.

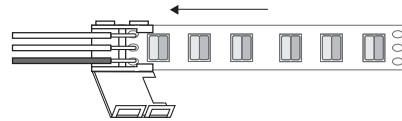

4 Close the CLICKTIGHT™ latch to ensure connection.



5 When ready for mounting, peel off the 3M™ adhesive backing of the tape and tear off along the connector tray edge. Mount tape light and utilize a wiring harness to secure lead wires.

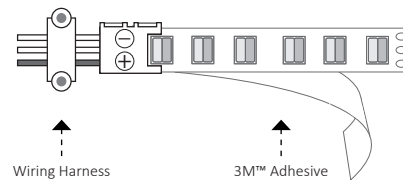

NOTE: CLASS 2

All CLICKTIGHT™ accessories have a Class 2 amperage limit: 60W/5A @ 12VDC; 96W/4A @ 24VDC. CLICKTIGHT connectors are not compatible with wet location tape light. See 'Troubleshooting' for tape light connector issues.

CLICKTIGHT™ CONNECTIVITY TIP

If connection is not secure, pull tape out from the CLICKTIGHT™ connector and trim any excess tape so the outer edges of contact/solder points are flush with the end of the tape. Insert trimmed end back into CLICKTIGHT™ connector with the 3M™ adhesive backing still in tact to tape.

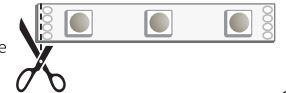

TROUBLESHOOTING

Prior to troubleshooting, ensure all items are a compatible system and main power is turned ON.

<p>Shift in brightness and/or kelvin</p>	<ul style="list-style-type: none"> Review maximum series run limits. Exceeding these limits will cause excess voltage drop, decreasing brightness and/or kelvin as the run is extended.
<p>Some LEDs are not functional</p>	<ul style="list-style-type: none"> Ensure all connections have been properly attached. Ensure fixture has not been bent excessively, which may cause components and solder to detach from the circuit board.
<p>Lights are flickering</p>	<ul style="list-style-type: none"> Ensure a compatible driver is installed. Ensure the pre-set mode of the controller is not on a dynamic mode. If lights continue to flicker, check for loose connections. Ensure tape light connectors are properly attached.
<p>Lights are turning on/off repeatedly</p>	<ul style="list-style-type: none"> Ensure driver is not overloaded. An overloaded driver will trip the internal auto-reset (of driver) repeatedly, turning the system on/off.
<p>CLICKTIGHT™ Connector Troubleshooting</p>	<ul style="list-style-type: none"> Ensure compatible CLICKTIGHT™ models are attached. Tape lights vary in width and require specific connectors. Contact your supplier for additional information. Tape light is polarity sensitive. Ensure the +/- markings of the CLICKTIGHT™ connector is aligned with the +/- markings of the tape. If polarity is backwards, reverse the lead wire connection or detach tape from CLICKTIGHT™ connector and reattach opposing end of tape to connector.

K-RANGE 24[®] 24V TUNABLE WHITE LED TAPE LIGHT

INSTALLATION GUIDE

SYSTEM DIAGRAMS

The following diagrams are provided as example system designs. Installations larger than one spool of tape light may require an alternate system design. Contact technical support or see the product web page for additional system examples. Always review each component installation guide for detailed and up-to-date wiring instructions.

K-RANGE[®] PLUG-IN ADAPTER SYSTEM

For small-scale kelvin-adjustable installations

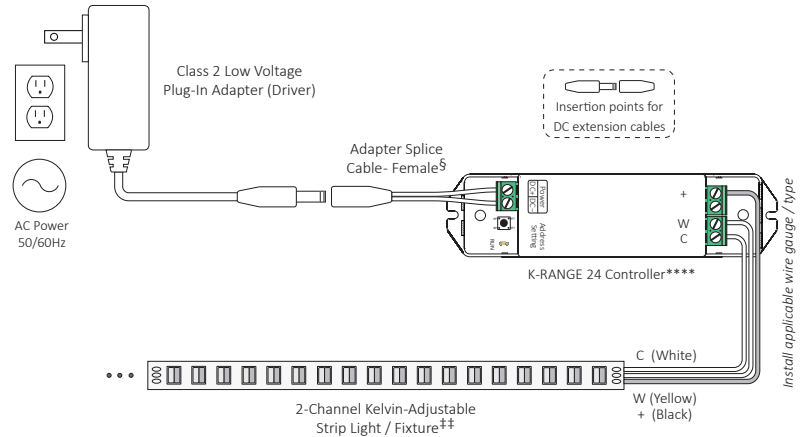

K-RANGE[®] HARD-WIRE SYSTEM

For small-scale kelvin-adjustable installations

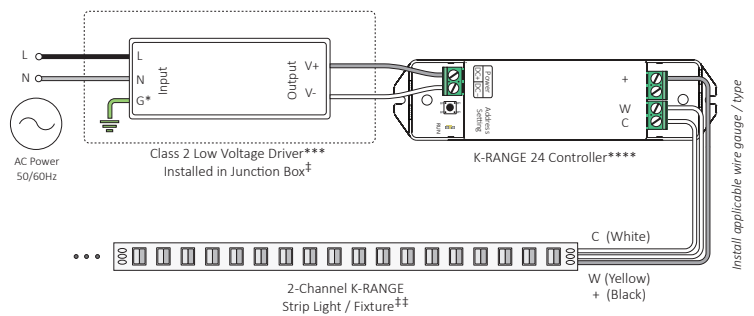

* Driver may not require a fault ground connection. Refer to driver specifications for additional information.

*** Install a Class 2 constant voltage driver compatible with a low voltage PWM controller/dimmer switch. Refer to each driver specification sheet for full power ratings & load deratings.

**** Determine the number of low voltage outputs of the driver when installing multiple PWM controllers/dimmer switches. No more than one PWM controller/dimmer switch can be attached to a single output of the driver.

‡ Refer to driver specifications for a compatible junction box.

‡‡ See fixture specifications for maximum series run limits.

§ See in-line accessories specifications for maximum amperage ratings.

ADDITIONAL RESOURCES

Visit the online product page at www.DiodeLED.com for additional product specifications & warranty information.

• **K-RANGE 24[®] 24V TUNABLE WHITE LED TAPE LIGHT SPECIFICATION SHEET**

• **VOLTAGE DROP CHARTS**

Use to specify appropriate wire gauge for installation. Available at the 'Tools & Resources' page at www.DiodeLED.com.

QUESTIONS?

Visit www.DiodeLED.com or contact Customer Support at info@DiodeLED.com or 1.877.817.6028 Monday through Friday, 7:00am- 5:00pm PST.